

RE-2043

继电器/ RER Series industrial Relay

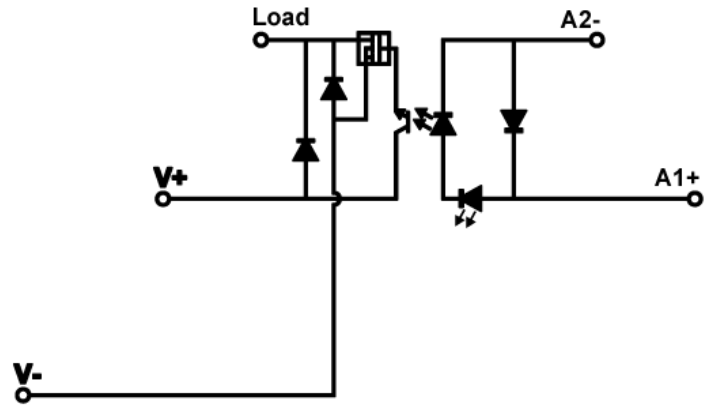
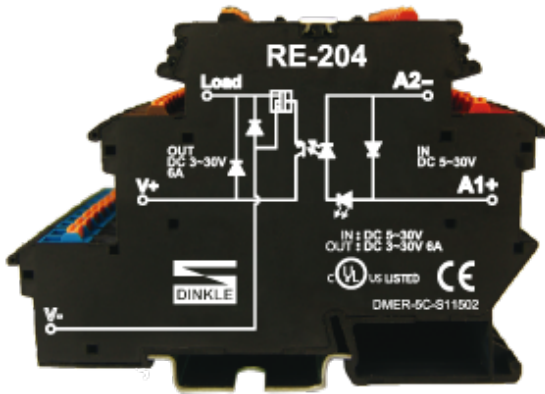

规格说明

额定输入电压	5~30 VDC	
额定输入电流	6mA	
状态指示灯	LED	
最大开关频率	100 Hz	
额定输出电压	3~30 VDC	
额定输出电流	6A	
电压降(Max.)	<1V	
工作温度	-25°C~60°C	
储藏温度	-40°C~70°C	
冲击耐压	2.5KV	
剥线长度	7~8mm	
绝缘材料	PA	
扭力(N·m)	--	
尺寸mm	6.2x61.7x91	
最小包装数	10pcs	
颜色说明	输入端	白、棕
	输出端	黑、棕、藍
订货规格(含短接片)	RE-2041 (含DS-210 X 3pcs)	